

ROTARY VALVE PRVT - TOURNIQUET

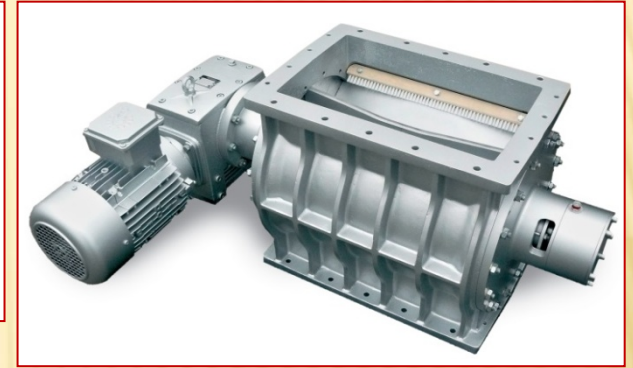
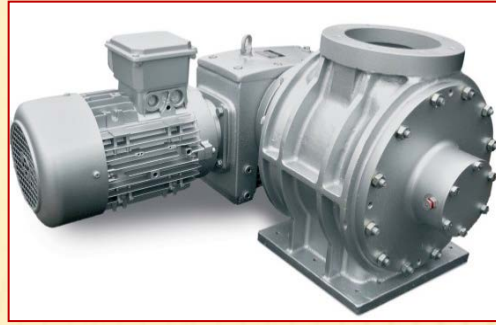
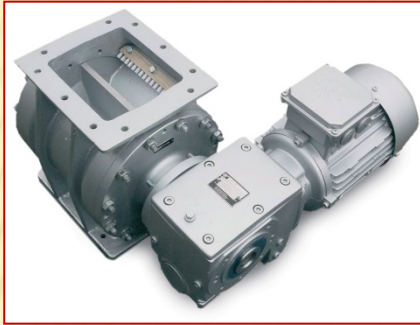

ROTARY VALVE PRVT - TOURNIQUET is available in three sizes and in two basic designs:

- Rotary valve – without packing a tourniquet
- Rotary valve – packing with tourniquet

The device is also supplied for all sizes and structural design with two rotors:

- Rotor with side plates
- Rotor without side plates

ALLOWS MOVEMENT OF PRODUCT BETWEEN TWO SPACES WITH DIFFERENT PRESURES

ROTARY VALVE PRVT -TOURNIQUET is a device that allows movement of product between two spaces with different pressures. It is certified as a protective system for use in potentially explosive atmospheres.

PIN MILL PKM 1

Rotor without side plates

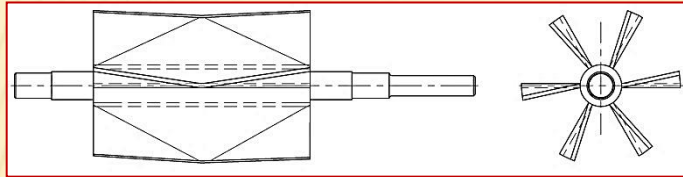

Rotor with side plates

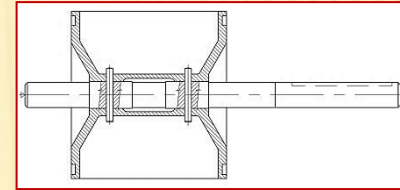

PRVT 200.K – XXXY/Z

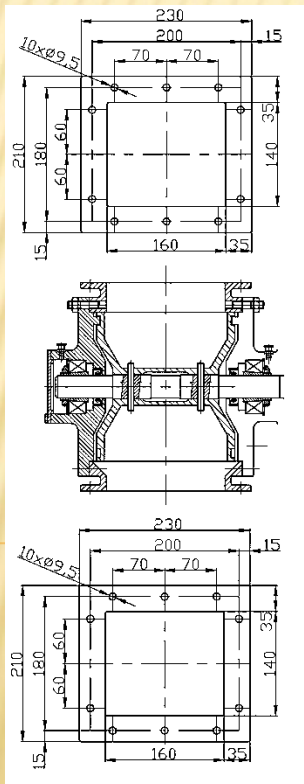

PRVT 250.K – XXXY/Z

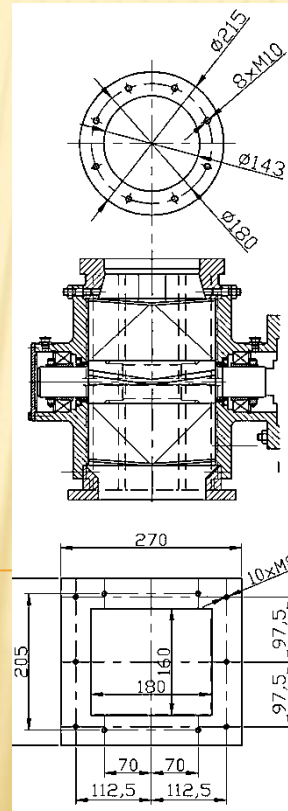

PRVT 315.K – XXXY/Z

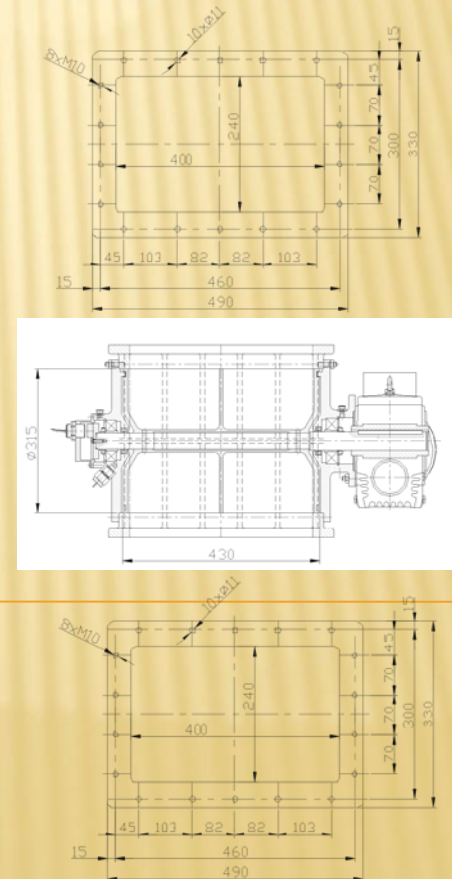

Dělnická 384
530 00 Pardubice
CZECH REPUBLIC

Táňa Mičková

tel.: + 420 775 200 898

Roman Janovský

tel.: + 420 728 332 250

e-mail: torofa@email.cz

web: www.torofa.cz

TOROF
The logo for TOROF consists of the word 'TOROF' in a bold, sans-serif font. The letters 'T', 'O', 'R', and 'F' are dark red, while the letter 'O' is replaced by a grey gear icon. The logo is positioned vertically on the left side of the page.